

10

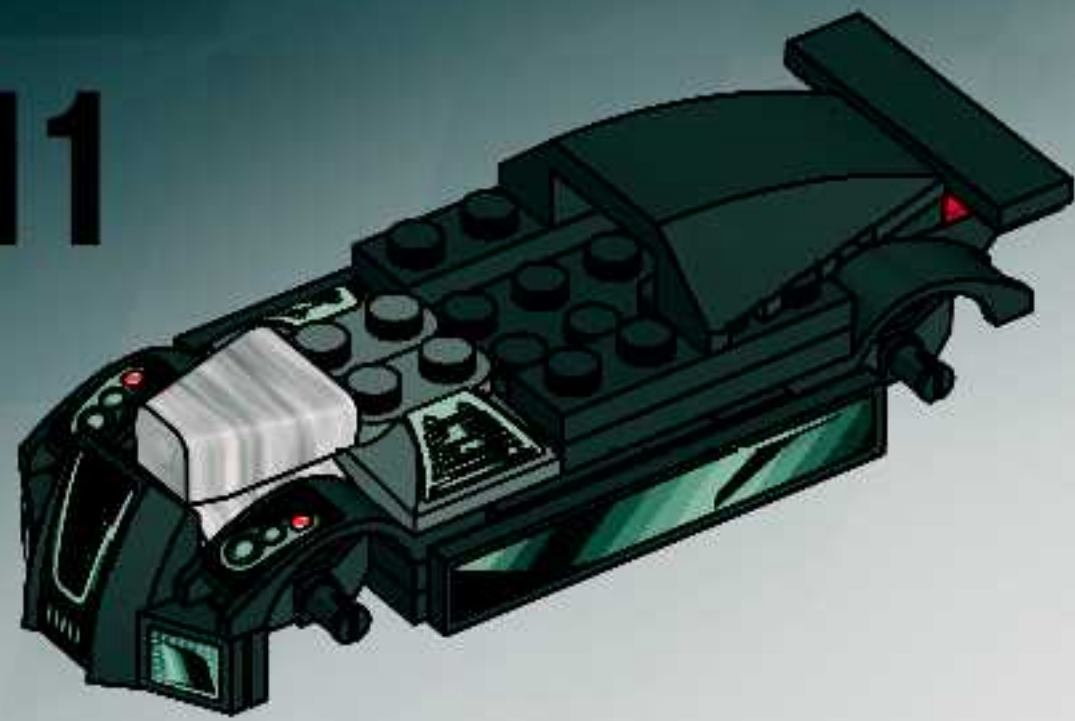

11



12

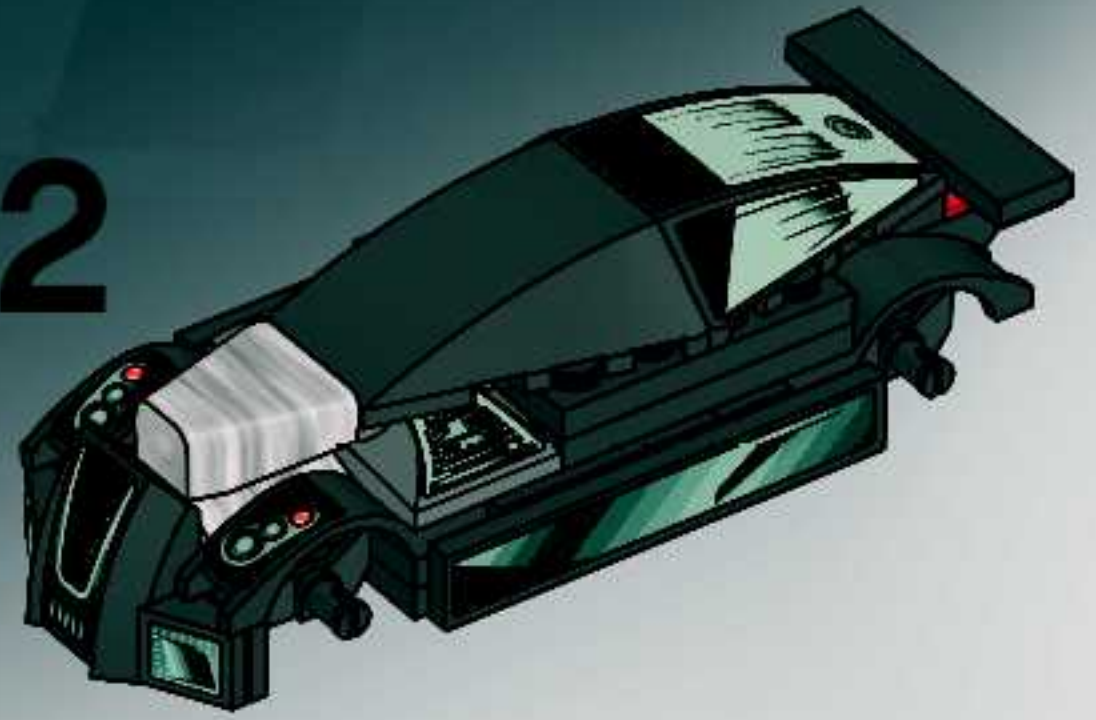

13

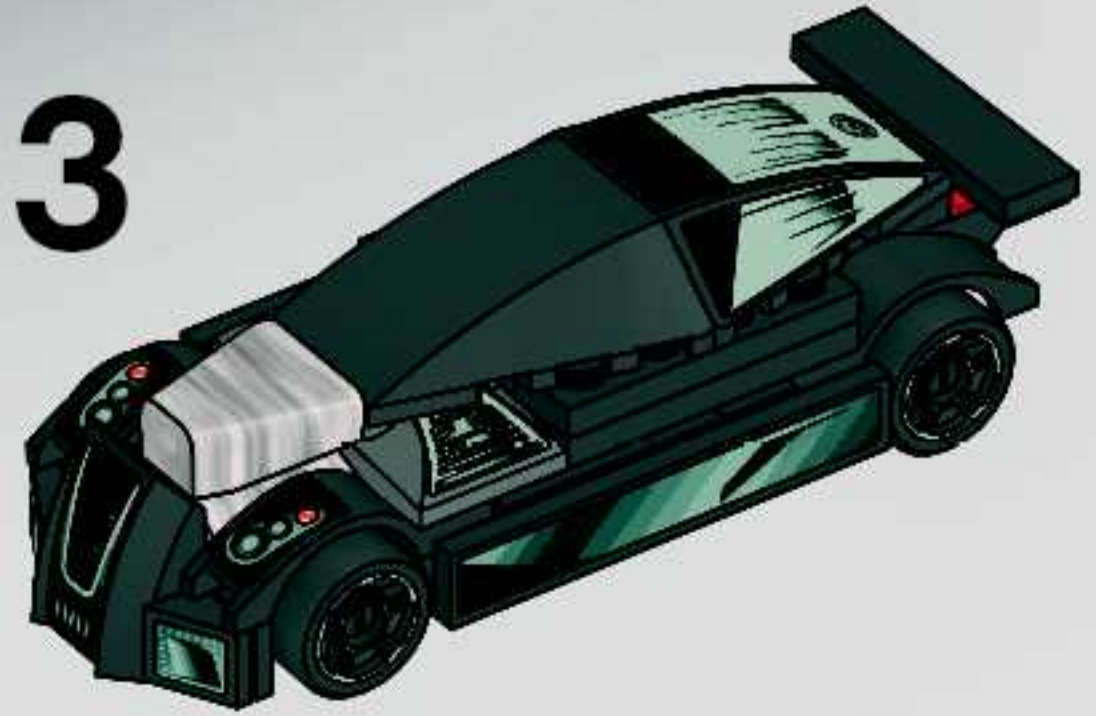

8132 + 8133



1

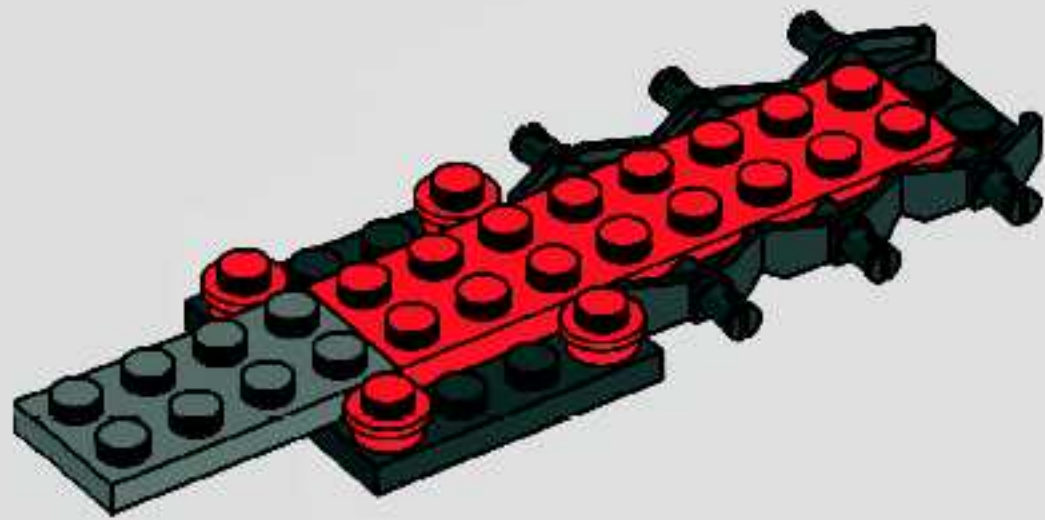

3

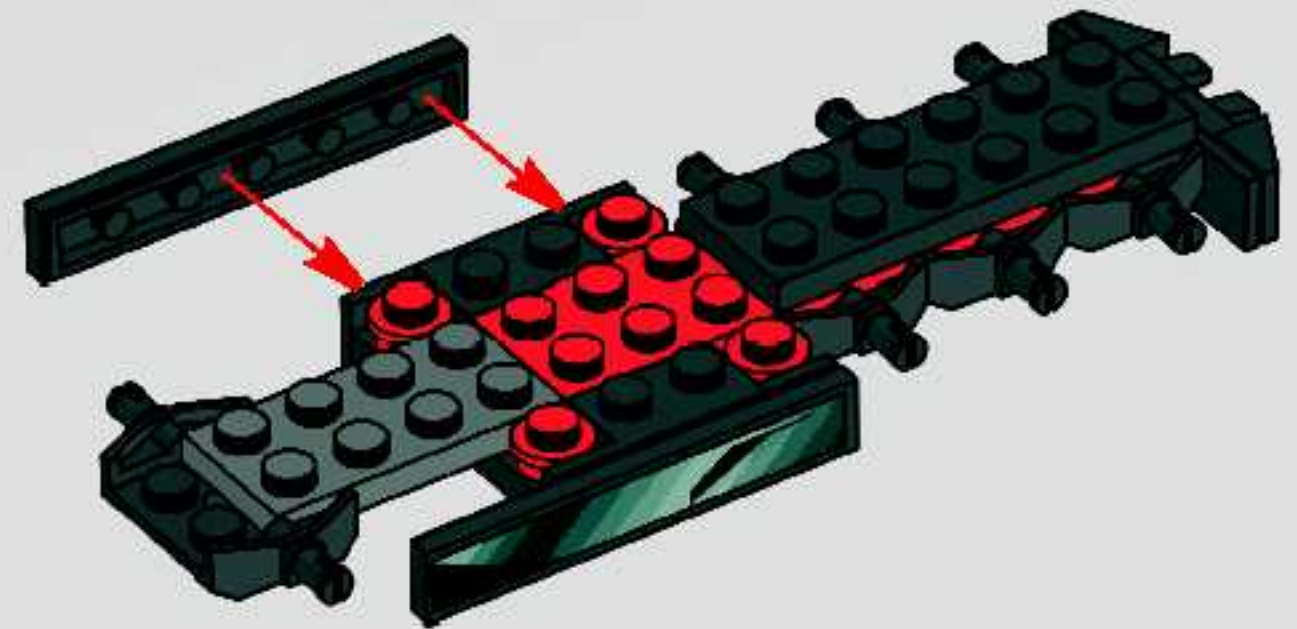

1

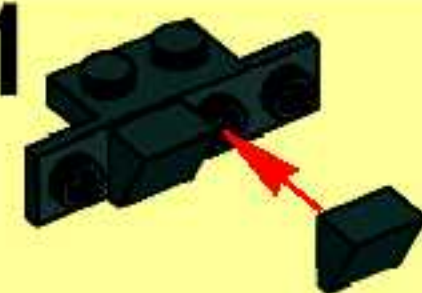

2



4

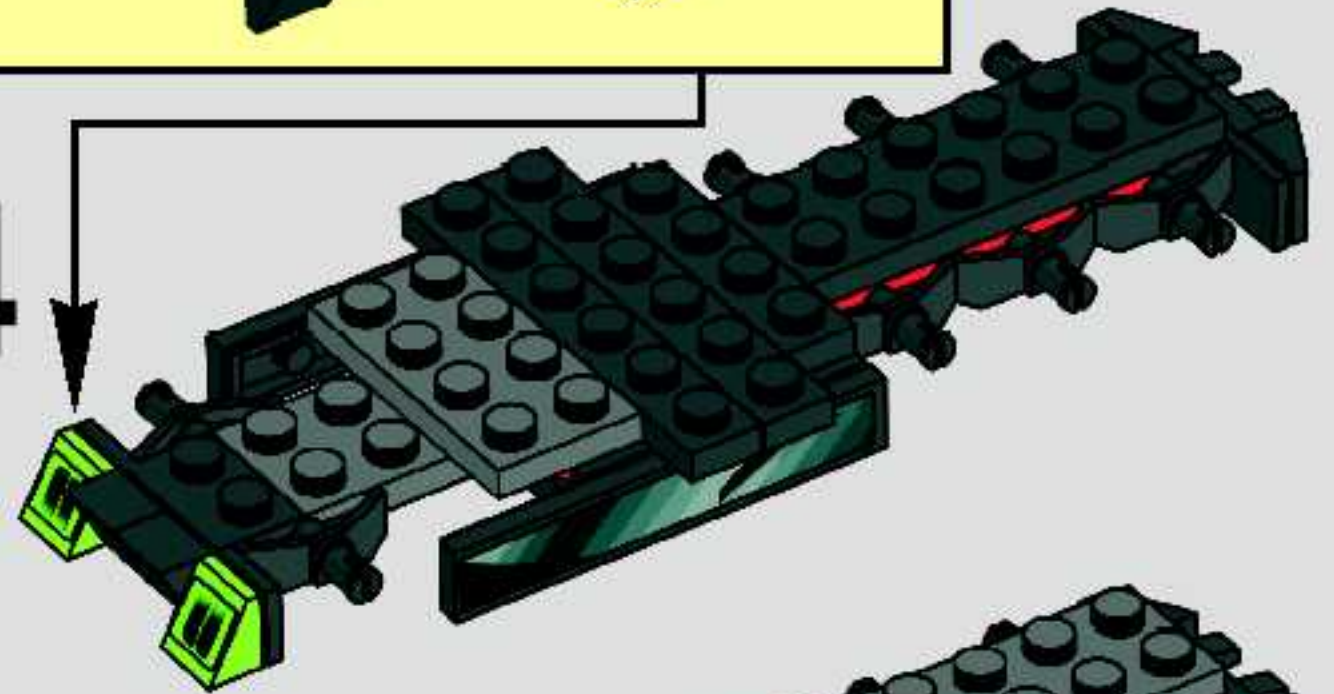

5

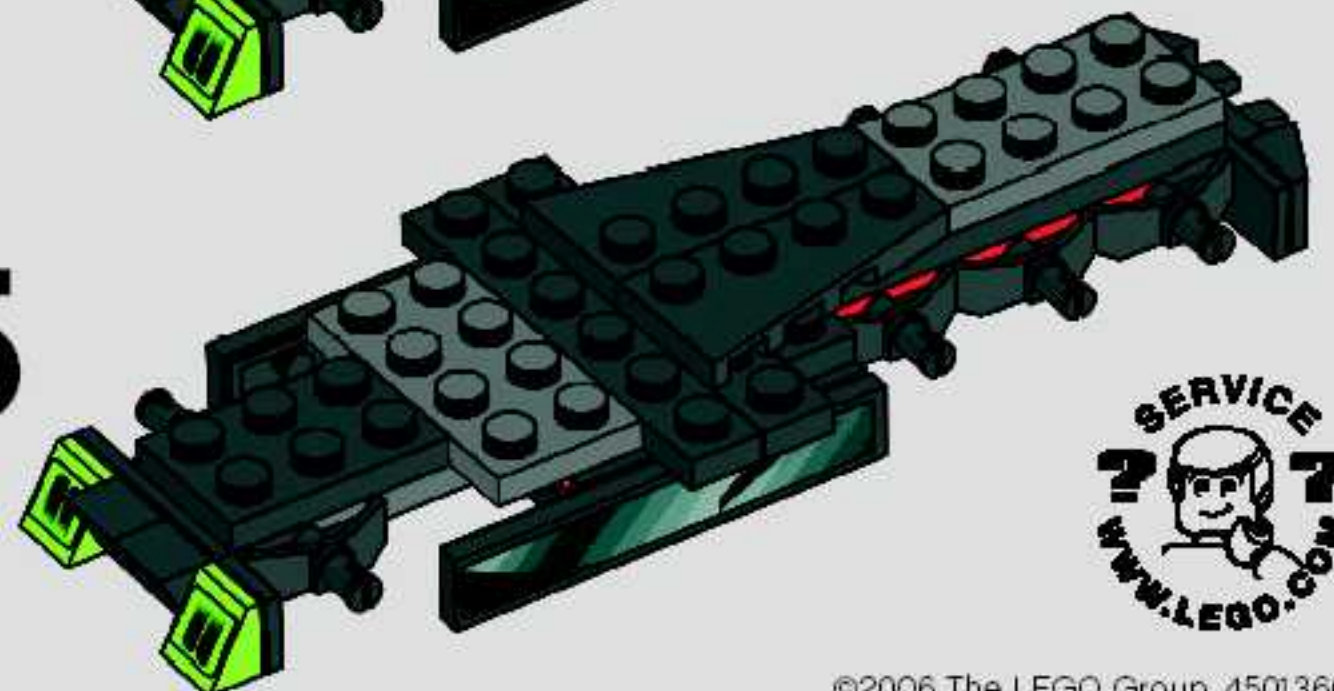

1

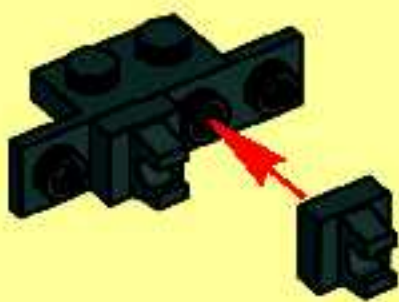

2



2

